

TOSHIBA Photocoupler GaAlAs IRED + Photo IC

TLP155E

Plasma Display Panel (PDP)
Industrial Inverter
MOS FET / IGBT Gate Driver

Unit: mm

The Toshiba TLP155E consists of GaAlAs infrared light emitting diodes and integrated high gain, high-speed photodetectors. The TLP155E is housed in the SO6 package.

The photodetector has an internal Faraday shield that provides a guaranteed common-mode transient immunity of ± 15 kV/ μ s. TLP155E is suitable for direct gate driving circuit for IGBTs or power MOSFETs.

- Buffer logic type (Totem pole output)
- Package type: SO6
- Peak Output Current : $I_{OP} = \pm 0.6$ A (max)
- Guaranteed performance over temperature: -40 to 100 °C
- Threshold Input Current: $I_{FLH} = 7.5$ mA (max)
- Propagation delay time : $t_{pLH} / t_{pHL} = 200$ ns (max)
- Common mode transient immunity : ± 15 kV/ μ s (min)
- Isolation voltage : $3750 V_{rms}$ (min)
- UL approved : UL1577, File No.E67349
- c-UL approved :CSA Component Acceptance Service No. 5A, File No.E67349
- Option(V4) VDE under application : EN60747-5-2
Maximum operating insulation voltage: 707 Vpk
Highest permissible over voltage: 6000 Vpk
(Note) When a EN60747-5-2 approved type is needed, Please designate the "option(V4)"

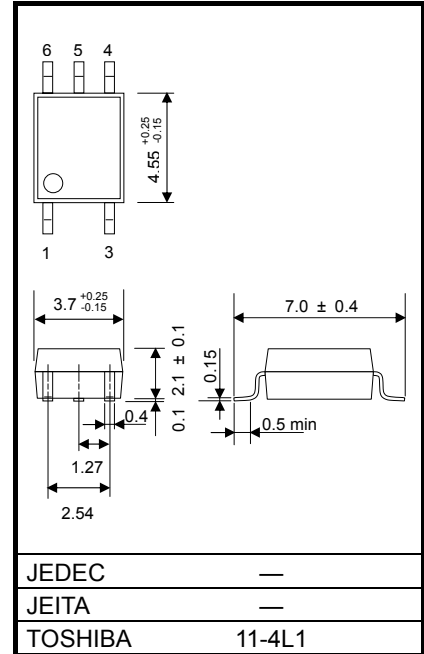

weight: 0.08 g (typ.)

Pin Configuration (Top View)

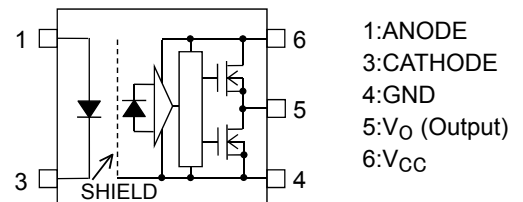

Truth Table

| Input | LED | M1 | M2 | Output |
|-------|-----|-----|-----|--------|
| H | ON | ON | OFF | H |
| L | OFF | OFF | ON | L |

Construction Mechanical Ratings

| | |
|----------------------|--------------|
| Creepage distance | 5.0 mm (min) |
| Clearance distance | 5.0 mm (min) |
| Insulation thickness | 0.4 mm (min) |

Schematic

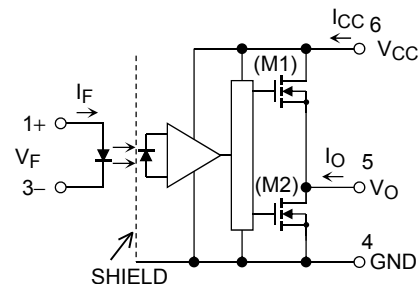

Start of commercial production
2010/08

Absolute Maximum Ratings (Ta = 25 °C)

| Characteristics | | Symbol | Rating | Unit |
|--|--------------------------------------|----------------------|------------|------------------|
| LED | Forward Current | I _F | 20 | mA |
| | Forward Current Derating (Ta ≥ 92°C) | ΔI _F / °C | -0.63 | mA/°C |
| | Pulse Forward Current (Note 1) | I _{FPT} | 1 | A |
| | Reverse Voltage | V _R | 5 | V |
| | Junction Temperature | T _J | 125 | °C |
| DETECTOR | "H" Peak Output Current (Note2) | I _{OPH} | -0.6 | A |
| | "L" Peak Output Current (Note2) | I _{OPL} | 0.6 | A |
| | Output Voltage | V _O | 35 | V |
| | Supply Voltage | V _{CC} | 35 | V |
| | Junction Temperature | T _J | 125 | °C |
| Operating frequency (Note3) | | f | 250 | kHz |
| Operating Temperature Range | | T _{opr} | -40 to 100 | °C |
| Storage Temperature Range | | T _{stg} | -55 to 125 | °C |
| Lead Soldering Temperature (10 s) | | T _{sol} | 260 | °C |
| Isolation Voltage (AC, 1 minute, R.H. ≤ 60%, Ta=25°C) (Note 4) | | BV _s | 3750 | V _{rms} |

Note: Using continuously under heavy loads (e.g. the application of high temperature/current/voltage and the significant change in temperature, etc.) may cause this product to decrease in the reliability significantly even if the operating conditions (i.e. operating temperature/current/voltage, etc.) are within the absolute maximum ratings.

Please design the appropriate reliability upon reviewing the Toshiba Semiconductor Reliability Handbook ("Handling Precautions"/"Derating Concept and Methods") and individual reliability data (i.e. reliability test report and estimated failure rate, etc.).

Note 1: Pulse width ≤ 1 μs, 300pps.

Note 2: Exponential waveform pulse width P_W ≤ 2 μs, f ≤ 10 kHz, V_{CC}=20V, Ta=-40 to 100°C

Note 3: Exponential waveform pulse width P_W ≤ 80 ns, I_{OPH} ≥ -0.25A, I_{OPL} ≤ 0.25A, V_{CC}=20V, Ta=-40 to 100°C

Note 4: This device is regarded as a two terminal device: pins 1 and 3 are shorted together, as are pins 4, 5 and 6.

Recommended Operating Conditions

| Characteristics | Symbol | Min | Typ. | Max | Unit |
|------------------------------------|-------------------------------------|-----|------|------|------|
| Input Current, High Level (Note 1) | I _{FLH} | 10 | - | 15 | mA |
| Input Voltage, Low Level | V _{FHL} | 0 | - | 0.8 | V |
| Supply Voltage* | V _{CC} | 10 | - | 30 | V |
| Peak output current | I _{OPH} / I _{OPL} | - | - | ±0.2 | A |
| Operating Temperature | T _{opr} | -40 | - | 100 | °C |

* This item denotes operating range, not meaning of recommended operating conditions.

Note: Recommended operating conditions are given as a design guideline to obtain expected performance of the device. Additionally, each item is an independent guideline respectively. In developing designs using this product, please confirm specified characteristics shown in this document.

Note 1: Input signal rise time (fall time) < 0.5 μs.

Electrical Characteristics (Ta = -40 to 100 °C, unless otherwise specified)

| Characteristics | Symbol | Test Circuit | Test Condition | Min | Typ.* | Max | Unit | |
|--|----------------------|-------------------|------------------------------------|---|---|--|-------|-----|
| Forward voltage | V _F | — | I _F = 10 mA, Ta = 25 °C | 1.40 | 1.55 | 1.80 | V | |
| Temperature coefficient of forward voltage | ΔV _F /ΔTa | — | I _F = 10 mA | — | -1.8 | — | mV/°C | |
| Input reverse current | I _R | — | V _R = 5 V, Ta = 25 °C | — | — | 10 | μA | |
| Input capacitance | C _T | — | V = 0 V, f = 1 MHz, Ta = 25 °C | — | 60 | — | pF | |
| Output current (Note 1) | "H" Level | I _{OPH1} | 1 | V _{CC} = 15 V I _F = 10 mA | V ₆₋₅ = 4 V | — | -0.5 | A |
| | | I _{OPH2} | | | V ₆₋₅ = 10 V | — | — | |
| | "L" Level | I _{OPL1} | 2 | V _{CC} = 15 V I _F = 0 mA | V ₅₋₄ = 2 V | 0.2 | 0.5 | — |
| | | I _{OPL2} | | | V ₅₋₄ = 10 V | 0.4 | — | — |
| Output voltage | "H" Level | V _{OH} | 3 | V _{CC} = 10 V | I _O = -100 mA, I _F = 10 mA | 6.0 | 8.4 | — |
| | "L" Level | V _{OL} | | | 4 | I _O = 100 mA, V _F = 0.8 V | — | 0.3 |
| Supply current | "H" Level | I _{CCH} | 5 | V _{CC} = 10 to 20 V V _O = Open | I _F = 10 mA | — | 1.5 | 3.0 |
| | "L" Level | I _{CCL} | | | 6 | I _F = 0 mA | — | 1.5 |
| Threshold input current | L → H | I _{FLH} | — | V _{CC} = 15 V, V _O > 1 V | — | 1.0 | 7.5 | mA |
| Threshold input voltage | H → L | V _{FHL} | — | V _{CC} = 15 V, V _O < 1 V | 0.8 | — | — | V |
| Supply voltage | V _{CC} | — | — | — | 10 | — | 30 | V |

*All typical values are at Ta=25°C.

Note: This product is more sensitive than conventional products to electrostatic discharge (ESD) owing to its low power consumption design. It is therefore all the more necessary to observe general precautions regarding ESD when handling this component.

Note 1: Duration of I_O time ≤ 50 μs, 1 pulse

Isolation Characteristics (Ta = 25 °C)

| Characteristics | Symbol | Test Condition | Min | Typ. | Max | Unit |
|-----------------------------|-----------------|--|--------------------|------------------|-----|------------------|
| Capacitance input to output | C _S | V _S = 0 V, f = 1MHz (Note 1) | — | 0.8 | — | pF |
| Isolation resistance | R _S | R.H. ≤ 60 %, V _S = 500 V (Note 1) | 1×10 ¹² | 10 ¹⁴ | — | Ω |
| Isolation voltage | BV _S | AC, 1 minute | 3750 | — | — | V _{rms} |
| | | AC, 1 second, in oil | — | 10000 | — | |
| | | DC, 1 minute, in oil | — | 10000 | — | V _{dc} |

Note 1: This device is regarded as a two terminal device: pins 1 and 3 are shorted together, as are pins 4, 5 and 6.

Switching Characteristics (NOTE)(Ta = -40 to 100 °C, unless otherwise specified)

| Characteristics | | Symbol | Test Circuit | Test Condition | Min | Typ.* | Max | Unit | | |
|---|-------|-------------------------------------|--------------|--|---|-------|-----|------|-------|--|
| Propagation delay time | L → H | t _{pLH} | 7 | V _{CC} = 20 V R _g = 30 Ω C _g = 1 nF f = 250kHz Duty = 50% | Ta = 25 °C I _F = 0 → 10 mA | — | 120 | 170 | ns | |
| | H → L | t _{pHL} | | | Ta = 25 °C I _F = 10 → 0 mA | — | 120 | 170 | | |
| | L → H | t _{pLH} | | | I _F = 0 → 10 mA | 50 | 120 | 200 | | |
| | H → L | t _{pHL} | | | I _F = 10 → 0 mA | 50 | 120 | 200 | | |
| Propagation delay skew (Note 1) | | t _{psk} | | | I _F = 0 ↔ 10 mA | -85 | — | 85 | | |
| Switching time dispersion | | t _{pHL} - t _{pLH} | | | I _F = 0 ↔ 10 mA | — | 5 | 50 | | |
| Output rise time (10–90 %) | | t _r | | | I _F = 0 → 10 mA | — | 35 | — | | |
| Output fall time (90–10 %) | | t _f | | | I _F = 10 → 0 mA | — | 15 | — | | |
| Common mode transient immunity at HIGH level output | | CM _H | 8 | V _{CM} = 1000 V _{p-p} V _{CC} = 20 V Ta = 25 °C | I _F = 10 mA V _{O (min)} = 16 V | -15 | — | — | kV/μs | |
| Common mode transient immunity at LOW level output | | CM _L | | | I _F = 0 mA V _{O (max)} = 1 V | 15 | — | — | | |

(*): All typical values are at Ta = 25 °C.

Note: A ceramic capacitor (0.1 μF) should be connected from pin 6 (V_{CC}) to pin 4 (GND) to stabilize the operation of the high gain linear amplifier. Failure to provide the bypass may impair the switching property.
The total lead length between capacitor and coupler should not exceed 1 cm.

Note 1: Propagation delay skew is defined as the difference between the largest and smallest propagation delay time (i.e. t_{pHL} or t_{pLH}) of multiple samples. Evaluations of these samples are conducted under identical test conditions (supply voltage, input current, temperature, etc.).

Test Circuit 1: I_{OPH}

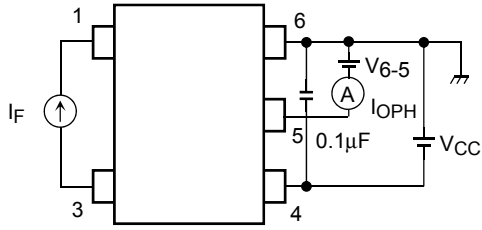

Test Circuit 2: I_{OPL}

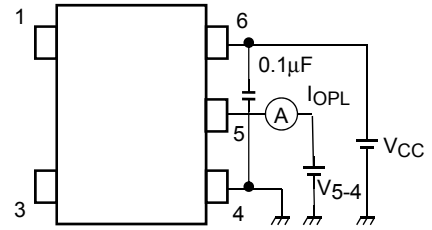

Test Circuit 3: V_{OH}

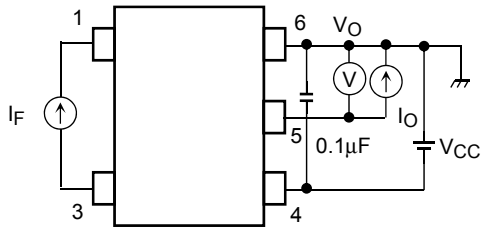

*V_{OH} = V_{CC} - V_O

Test Circuit 4: V_{OL}

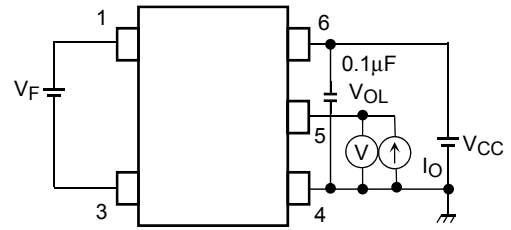

Test Circuit 5: I_{CCH}

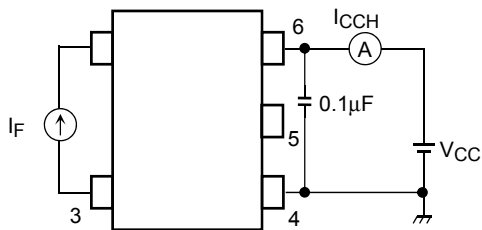

Test Circuit 6: I_{CCL}

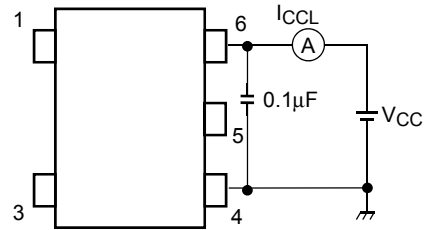

Test Circuit 7: t_{pLH} , t_{pHL} , t_r , t_f , $|t_{pHL}-t_{pLH}|$

$I_F=10\text{mA}$ (P.G)
 ($f=250\text{kHz}$, $\text{duty}=50\%$, $t_r=t_f=5\text{ns}$)

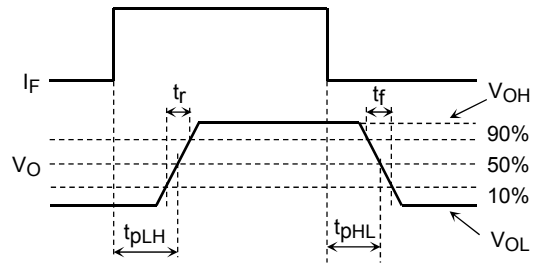
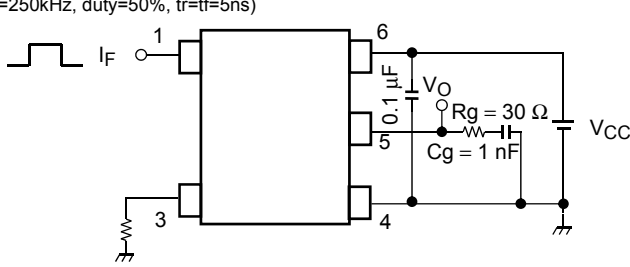

Test Circuit 8: CM_H , CM_L

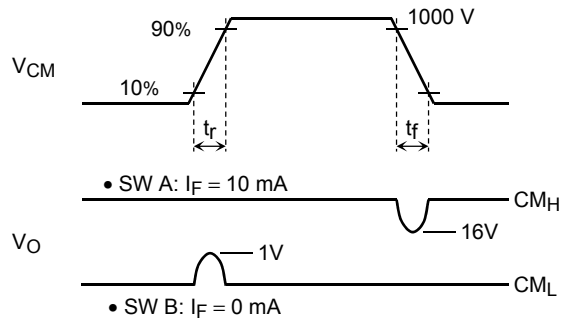
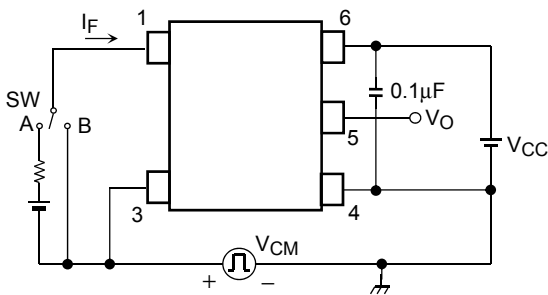

$$CM_L = \frac{800 \text{ V}}{t_f (\mu\text{s})}$$

$$CM_H = - \frac{800 \text{ V}}{t_f (\mu\text{s})}$$

CM_L (CM_H) is the maximum rate of rise (fall) of the common mode voltage that can be sustained with the output voltage in the LOW (HIGH) state.

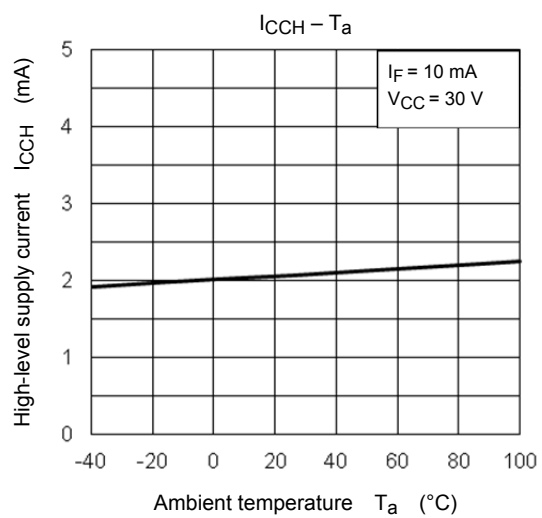
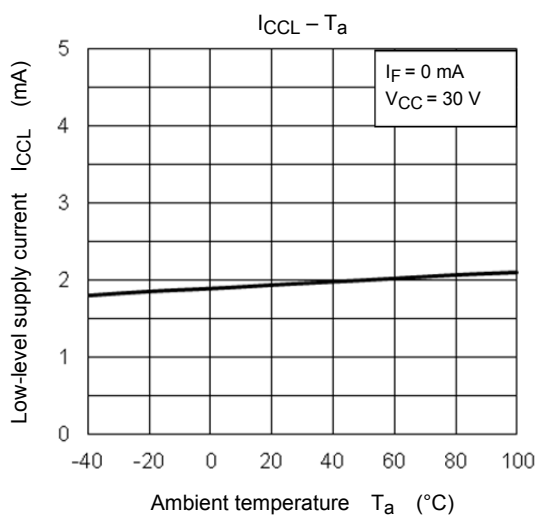
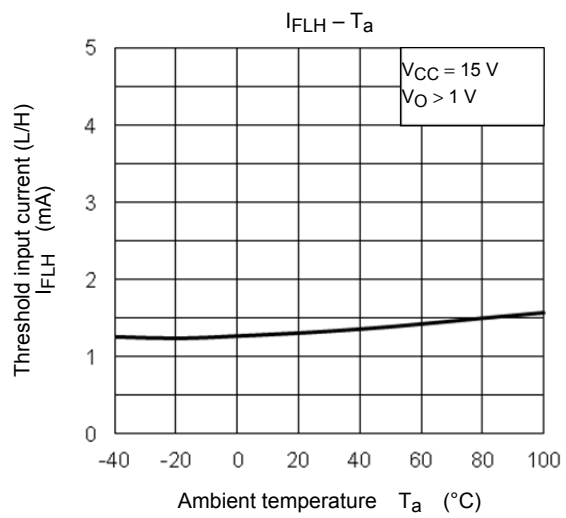
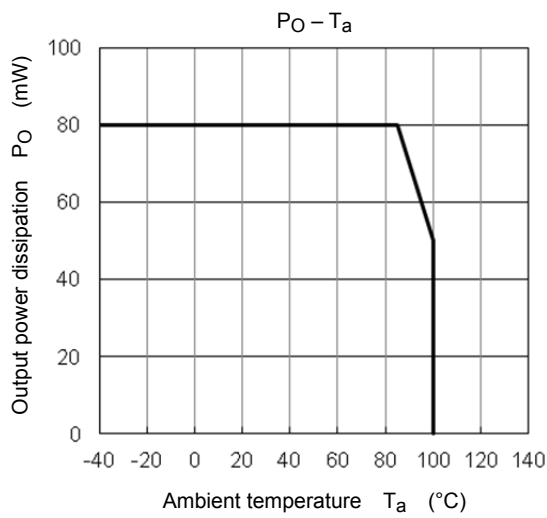
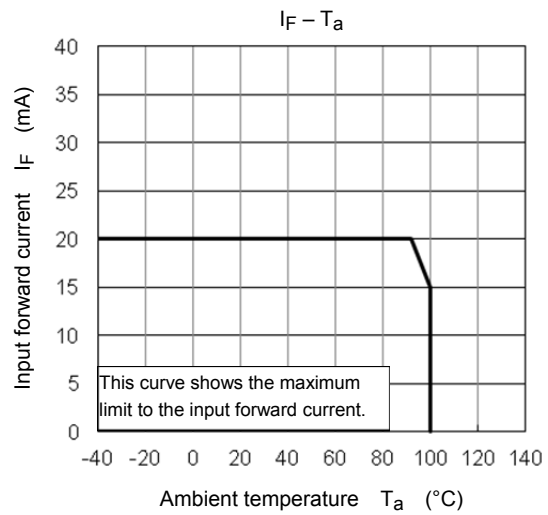
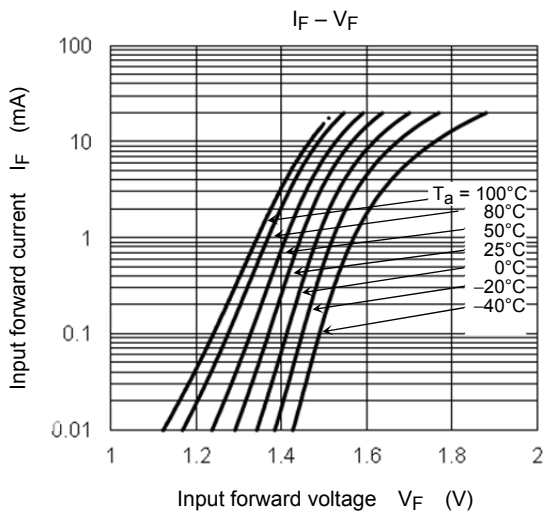

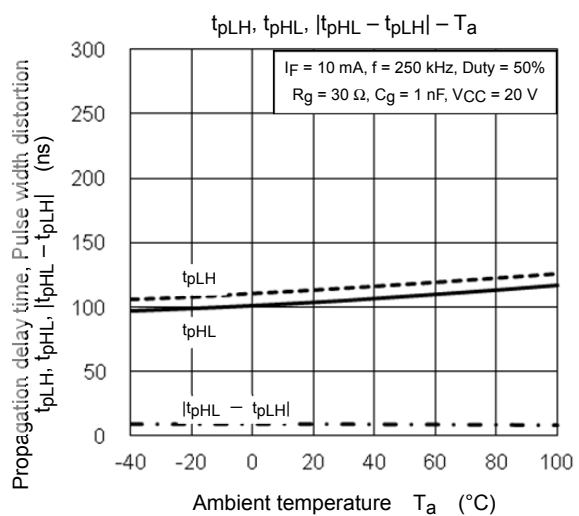
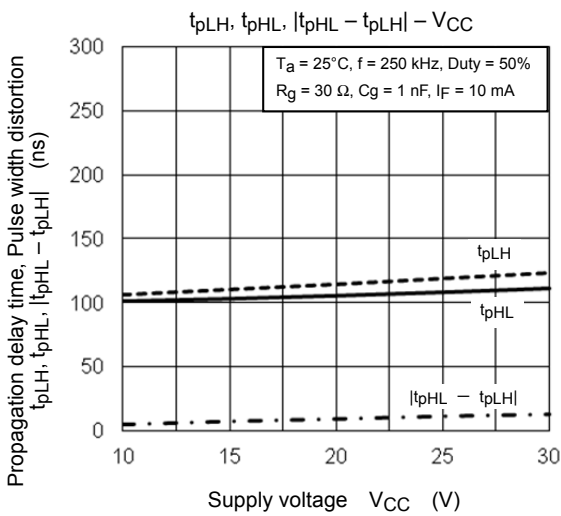
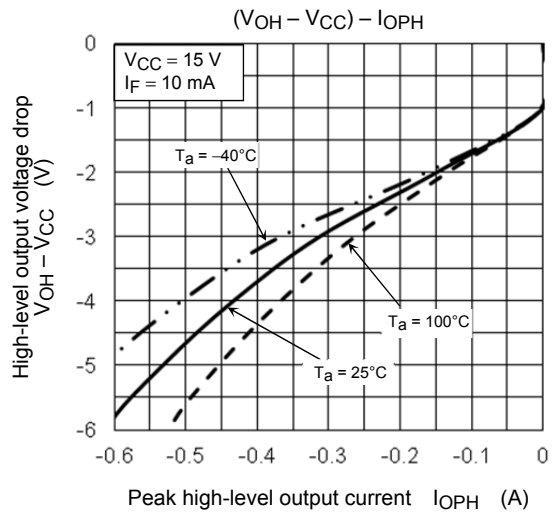
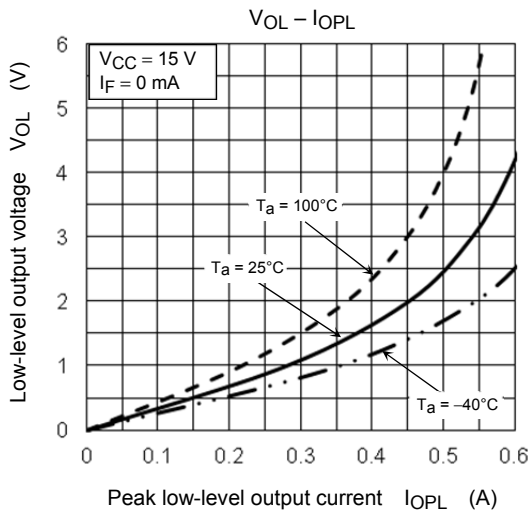
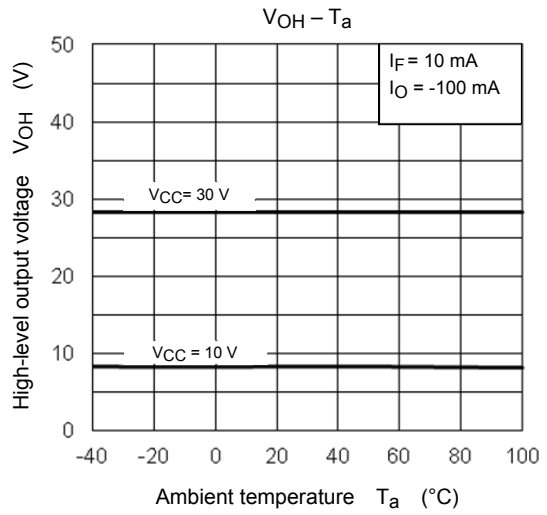
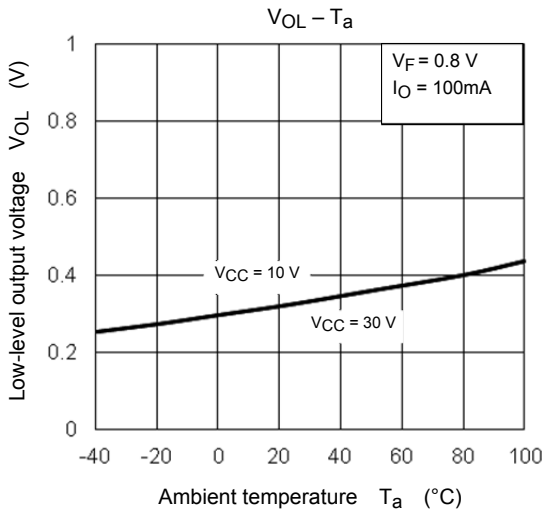

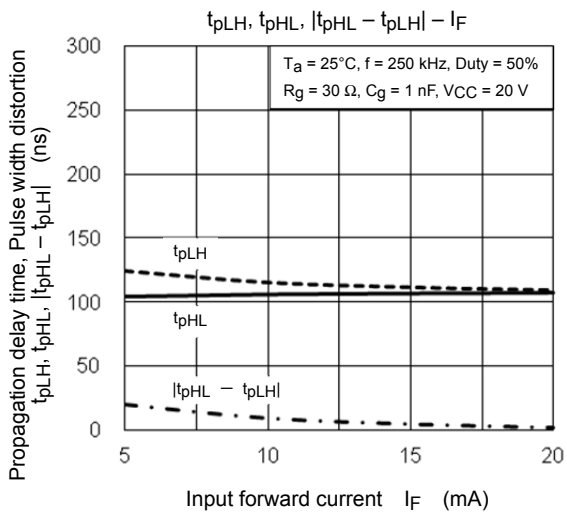

NOTE: The above characteristics curves are presented for reference only and not guaranteed by production test, unless otherwise noted.

PRECAUTIONS OF SURFACE MOUNTING TYPE PHOTOCOUPLER SOLDERING & GENERAL STORAGE

(1) Precautions for Soldering

1) When Using Soldering Reflow

- An example of a temperature profile when Sn-Pb eutectic solder is used:

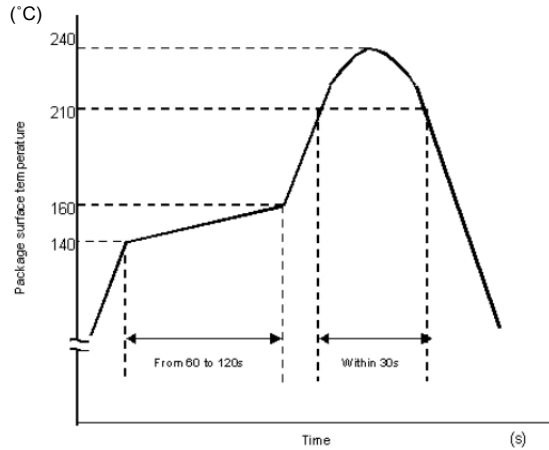

- An example of a temperature profile when lead(Pb)-free solder is used:

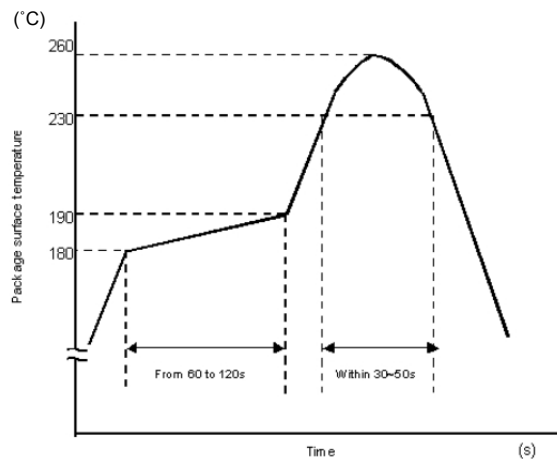

- Reflow soldering must be performed once or twice.
- The mounting should be completed with the interval from the first to the last mountings being 2 weeks.

2) When using soldering Flow (Applicable to both eutectic solder and Lead(Pb)-Free solder)

- Apply preheating of 150 °C for 60 to 120 seconds.
- Mounting condition of 260 °C and less within 10 seconds is recommended.
- Flow soldering must be performed once

3) When using soldering Iron (Applicable to both eutectic solder and Lead(Pb)-Free solder)

- Complete soldering within 10 seconds for lead temperature not exceeding 260 °C or within 3 seconds not exceeding 350 °C .
- Heating by soldering iron must be only once per 1 lead

(2) Precautions for General Storage

- 1) Do not store devices at any place where they will be exposed to moisture or direct sunlight.
- 2) When transportation or storage of devices, follow the cautions indicated on the carton box.
- 3) The storage area temperature should be kept within a temperature range of 5 °C to 35 °C, and relative humidity should be maintained at between 45% and 75%.
- 4) Do not store devices in the presence of harmful (especially corrosive) gases, or in dusty conditions.
- 5) Use storage areas where there is minimal temperature fluctuation. Because rapid temperature changes can cause condensation to occur on stored devices, resulting in lead oxidation or corrosion, as a result, the solderability of the leads will be degraded.
- 6) When repacking devices, use anti-static containers.
- 7) Do not apply any external force or load directly to devices while they are in storage.
- 8) If devices have been stored for more than two years, even though the above conditions have been followed, it is recommended that solderability of them should be tested before they are used.

Specification for Embossed-Tape Packing (TPL)(TPR) for SO6 Coupler

1. Applicable Package

| | |
|---------|-------------------|
| Package | Product Type |
| SO6 | Mini-flat coupler |

2. Product Naming System

Type of package used for shipment is denoted by a symbol suffix after a product number. The method of classification is as below.

(Example)

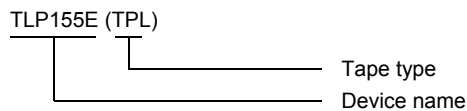

3. Tape Dimensions

3.1 Specification Classification Are as Shown in Table 1

Table 1 Tape Type Classification

| Tape type | Classification | Quantity (pcs / reel) |
|-----------|----------------|-----------------------|
| TPL | L direction | 3000 |
| TPR | R direction | 3000 |

3.2 Orientation of Device in Relation to Direction of Tape Movement

Device orientation in the recesses is as shown in Figure 1.

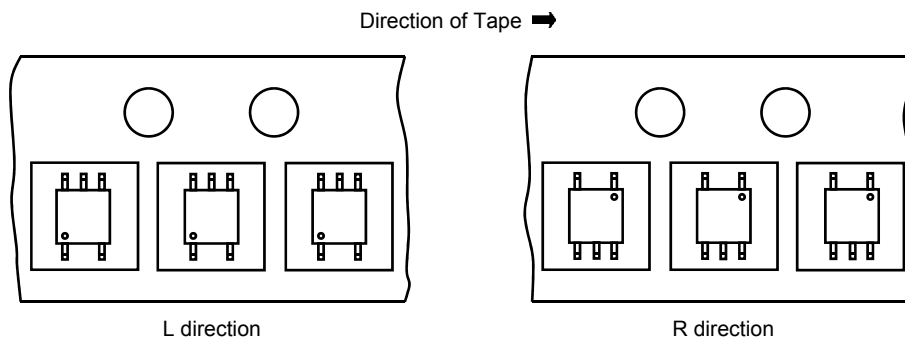

Figure 1 Device Orientation

3.3 Empty Device Recesses Are as Shown in Table 2.

Table 2 Empty Device Recesses

| | Standard | Remarks |
|---|--------------------------|--|
| Occurrences of 2 or more successive empty device recesses | 0 | Within any given 40-mm section of tape, not including leader and trailer |
| Single empty device recesses | 6 devices (max) per reel | Not including leader and trailer |

3.4 Start and End of Tape

The start of the tape has 50 or more empty holes. The end of tape has 50 or more empty holes and two empty turns only for a cover tape.

3.5 Tape Specification

- (1) Tape material: Plastic (protection against electrostatics)
- (2) Dimensions: The tape dimensions are as shown in Figure 2 and Table 3.

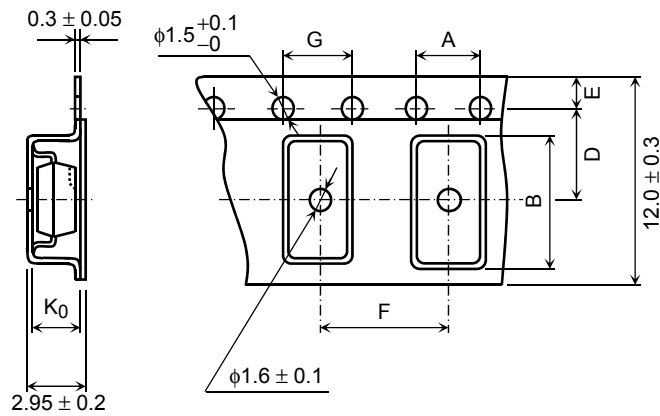

Figure 2 Tape Forms

Table 3 Tape Dimensions

Unit: mm
Unless otherwise specified: ±0.1

| Symbol | Dimension | Remark |
|----------------|-----------|---|
| A | 4.0 | — |
| B | 7.6 | — |
| D | 5.5 | Center line of indented square hole and sprocket hole |
| E | 1.75 | Distance between tape edge and hole center |
| F | 8.0 | Cumulative error $\begin{matrix} +0.1 \\ -0.3 \end{matrix}$ (max) per 10 feed holes |
| G | 4.0 | Cumulative error $\begin{matrix} +0.1 \\ -0.3 \end{matrix}$ (max) per 10 feed holes |
| K ₀ | 2.6 | Internal space |

3.6 Reel

- (1) Material: Plastic
- (2) Dimensions: The reel dimensions are as shown in Figure 3 and Table 4.

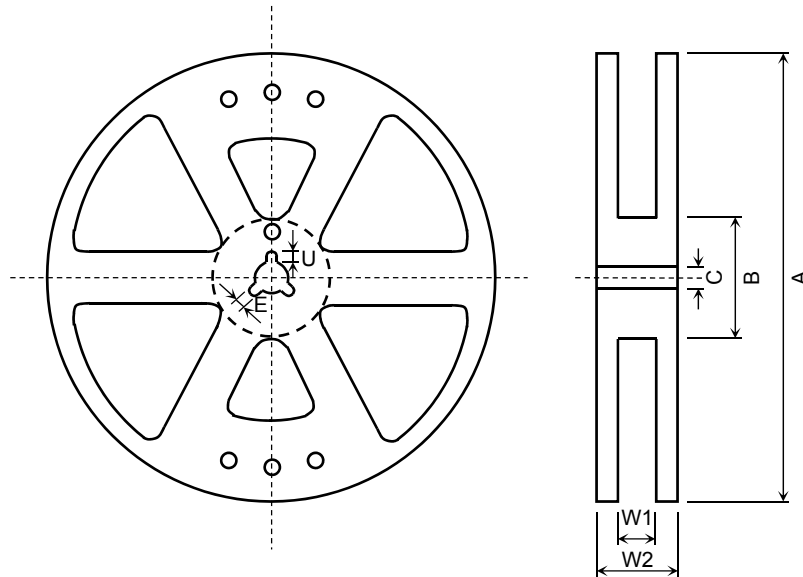

Figure 3 Reel Form

Table 4 Reel Dimensions

Unit: mm

| Symbol | Dimension |
|--------|-------------------|
| A | $\Phi 380 \pm 2$ |
| B | $\Phi 80 \pm 1$ |
| C | $\Phi 13 \pm 0.5$ |
| E | 2.0 ± 0.5 |
| U | 4.0 ± 0.5 |
| W1 | 13.5 ± 0.5 |
| W2 | 17.5 ± 1.0 |

4. Packing

Either one reel or five reels of photocoupler are packed in a shipping carton.

5. Label Indication

The carton bears a label indicating the product number, the symbol representing classification of standard, the quantity, the lot number and the Toshiba company name.

6. Ordering Method

When placing an order, please specify the product number, the tape type and the quantity as shown in the following example.

(Example)

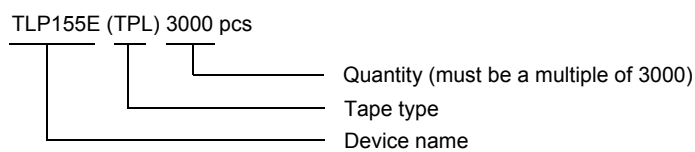

RESTRICTIONS ON PRODUCT USE

- Toshiba Corporation, and its subsidiaries and affiliates (collectively "TOSHIBA"), reserve the right to make changes to the information in this document, and related hardware, software and systems (collectively "Product") without notice.
- This document and any information herein may not be reproduced without prior written permission from TOSHIBA. Even with TOSHIBA's written permission, reproduction is permissible only if reproduction is without alteration/omission.
- Though TOSHIBA works continually to improve Product's quality and reliability, Product can malfunction or fail. Customers are responsible for complying with safety standards and for providing adequate designs and safeguards for their hardware, software and systems which minimize risk and avoid situations in which a malfunction or failure of Product could cause loss of human life, bodily injury or damage to property, including data loss or corruption. Before customers use the Product, create designs including the Product, or incorporate the Product into their own applications, customers must also refer to and comply with (a) the latest versions of all relevant TOSHIBA information, including without limitation, this document, the specifications, the data sheets and application notes for Product and the precautions and conditions set forth in the "TOSHIBA Semiconductor Reliability Handbook" and (b) the instructions for the application with which the Product will be used with or for. Customers are solely responsible for all aspects of their own product design or applications, including but not limited to (a) determining the appropriateness of the use of this Product in such design or applications; (b) evaluating and determining the applicability of any information contained in this document, or in charts, diagrams, programs, algorithms, sample application circuits, or any other referenced documents; and (c) validating all operating parameters for such designs and applications. **TOSHIBA ASSUMES NO LIABILITY FOR CUSTOMERS' PRODUCT DESIGN OR APPLICATIONS.**
- **PRODUCT IS NEITHER INTENDED NOR WARRANTED FOR USE IN EQUIPMENTS OR SYSTEMS THAT REQUIRE EXTRAORDINARILY HIGH LEVELS OF QUALITY AND/OR RELIABILITY, AND/OR A MALFUNCTION OR FAILURE OF WHICH MAY CAUSE LOSS OF HUMAN LIFE, BODILY INJURY, SERIOUS PROPERTY DAMAGE AND/OR SERIOUS PUBLIC IMPACT ("UNINTENDED USE").** Except for specific applications as expressly stated in this document, Unintended Use includes, without limitation, equipment used in nuclear facilities, equipment used in the aerospace industry, medical equipment, equipment used for automobiles, trains, ships and other transportation, traffic signaling equipment, equipment used to control combustions or explosions, safety devices, elevators and escalators, devices related to electric power, and equipment used in finance-related fields. **IF YOU USE PRODUCT FOR UNINTENDED USE, TOSHIBA ASSUMES NO LIABILITY FOR PRODUCT.** For details, please contact your TOSHIBA sales representative.
- Do not disassemble, analyze, reverse-engineer, alter, modify, translate or copy Product, whether in whole or in part.
- Product shall not be used for or incorporated into any products or systems whose manufacture, use, or sale is prohibited under any applicable laws or regulations.
- The information contained herein is presented only as guidance for Product use. No responsibility is assumed by TOSHIBA for any infringement of patents or any other intellectual property rights of third parties that may result from the use of Product. No license to any intellectual property right is granted by this document, whether express or implied, by estoppel or otherwise.
- **ABSENT A WRITTEN SIGNED AGREEMENT, EXCEPT AS PROVIDED IN THE RELEVANT TERMS AND CONDITIONS OF SALE FOR PRODUCT, AND TO THE MAXIMUM EXTENT ALLOWABLE BY LAW, TOSHIBA (1) ASSUMES NO LIABILITY WHATSOEVER, INCLUDING WITHOUT LIMITATION, INDIRECT, CONSEQUENTIAL, SPECIAL, OR INCIDENTAL DAMAGES OR LOSS, INCLUDING WITHOUT LIMITATION, LOSS OF PROFITS, LOSS OF OPPORTUNITIES, BUSINESS INTERRUPTION AND LOSS OF DATA, AND (2) DISCLAIMS ANY AND ALL EXPRESS OR IMPLIED WARRANTIES AND CONDITIONS RELATED TO SALE, USE OF PRODUCT, OR INFORMATION, INCLUDING WARRANTIES OR CONDITIONS OF MERCHANTABILITY, FITNESS FOR A PARTICULAR PURPOSE, ACCURACY OF INFORMATION, OR NONINFRINGEMENT.**
- GaAs (Gallium Arsenide) is used in Product. GaAs is harmful to humans if consumed or absorbed, whether in the form of dust or vapor. Handle with care and do not break, cut, crush, grind, dissolve chemically or otherwise expose GaAs in Product.
- Do not use or otherwise make available Product or related software or technology for any military purposes, including without limitation, for the design, development, use, stockpiling or manufacturing of nuclear, chemical, or biological weapons or missile technology products (mass destruction weapons). Product and related software and technology may be controlled under the applicable export laws and regulations including, without limitation, the Japanese Foreign Exchange and Foreign Trade Law and the U.S. Export Administration Regulations. Export and re-export of Product or related software or technology are strictly prohibited except in compliance with all applicable export laws and regulations.
- Please contact your TOSHIBA sales representative for details as to environmental matters such as the RoHS compatibility of Product. Please use Product in compliance with all applicable laws and regulations that regulate the inclusion or use of controlled substances, including without limitation, the EU RoHS Directive. **TOSHIBA ASSUMES NO LIABILITY FOR DAMAGES OR LOSSES OCCURRING AS A RESULT OF NONCOMPLIANCE WITH APPLICABLE LAWS AND REGULATIONS.**