

Evaluating Universal Precision High-Voltage Op Amps in SOIC Packages

FEATURES

Footprint for 8-pin SOIC with bottom thermal pad
Locations for passive filter components

GENERAL DESCRIPTION

The EVALPRAHVOPAMP-1RZ is an evaluation board that accommodates single op amps in SOIC packages. It provides the user with multiple choices and extensive flexibility for different applications circuits and configurations. This board is not intended to be used with high frequency components or high speed amplifiers; however, it provides the user with many combinations for various circuit types such as active filters, differential amplifiers, and external frequency compensation circuits. A few examples of application circuits are shown in this user guide.

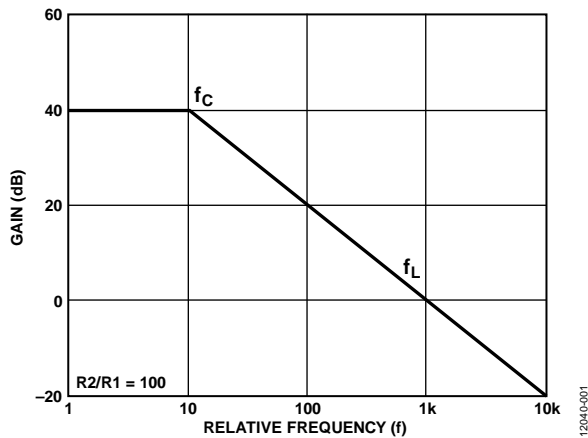
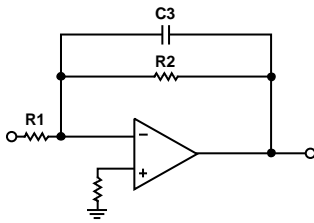

Figure 1. Simple Low-Pass Filter

LOW-PASS FILTER

Figure 1 is a typical representation of a first-order low-pass filter. This circuit has a 6 dB per octave roll-off after a closed loop -3 dB point defined by f_c . Gain below this frequency is defined as the magnitude of R_2 to R_1 . The circuit can be considered an ac integrator for frequencies well above f_c ; however, the time domain response is that of a single RC, rather than an integral.

$$f_c = 1/(2\pi \times R_2 \times C_3); -3 \text{ dB frequency}$$

$$f_L = 1/(2\pi \times R_1 \times C_3); \text{unity gain frequency}$$

$$A_{CL} = -(R_2/R_1); \text{closed loop gain}$$

Choose R_4 equal to the parallel combination between R_2 and R_1 in order to minimize errors due to bias currents.

DIFFERENCE AMPLIFIER AND PERFORMANCE OPTIMIZATION

Figure 2 shows an op amp configured as a difference amplifier. The difference amplifier is the complement of the summing amplifier, and allows the subtraction of two voltages or the cancellation of a signal common to both inputs. The circuit shown in

Figure 2 is useful as a computational amplifier in making a differential-to-single-ended conversion or in rejecting a common-mode signal. The output voltage V_{OUT} is comprised of two separate components:

1. A component V_{OUT1} due to V_{IN1} acting alone (V_{IN2} short-circuited to ground).
2. A component V_{OUT2} due to V_{IN2} acting alone (V_{IN1} short-circuited to ground).

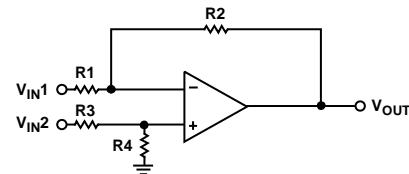

Figure 2. Difference Amplifier

The algebraic sum of these two components must be equal to V_{OUT} . By applying the principles expressed in the output voltage V_{OUT} components, and by letting $R_3 = R_1$ and $R_4 = R_2$, then:

$$V_{OUT1} = V_{IN1} R_2/R_1$$

$$V_{OUT2} = -V_{IN2} R_2/R_1$$

$$V_{OUT} = V_{OUT1} + V_{OUT2} = (V_{IN1} - V_{IN2}) R_2/R_1$$

Difference amplifiers are commonly used in high-accuracy circuits to improve the common-mode rejection ratio (CMRR).

For this type of application, CMRR depends upon how tightly matched resistors are used. Poorly matched resistors result in a low value of CMRR.

To see how this works, consider a hypothetical source of error for resistor R7 (1 - error). Using the superposition principle and letting R4 = R2 and R7 = R6, the output voltage is as follows:

$$V_{OUT} = \left\{ \frac{\left[\frac{R2}{R1} \left(1 - \frac{R1 + 2R2}{R1 + R2} \right) \times \frac{error}{2} \right]}{VD + \left(\frac{R2}{R1 + R2} \times error \right)} \right\}$$

$$V_{DD} = V_{IN2} - V_{IN1}$$

From this equation, A_{CM} and A_{DM} can be defined as follows:

$$A_{CM} = R2 / (R2 - R1) \times error$$

$$A_{DM} = R2 / R1 \times \{ 1 - [(R1 + 2R2 / R1 + R2) \times error / 2] \}$$

These equations demonstrate that when there is no error in the resistor values, the $A_{CM} = 0$ and the amplifier responds only to the differential voltage applied to its inputs. Under these conditions, the CMRR of the circuit is highly dependent on the CMRR of the amplifier selected for this job.

As mentioned above, errors introduced by resistor mismatch can be a big drawback of discrete differential amplifiers, but there are different ways to optimize this circuit configuration:

1. The differential gain is directly related to the ratio R2/R1. Therefore, one way to optimize the performance of this circuit is to place the amplifier in a high gain configuration. When larger values for resistors R2 and R4 and smaller values for resistors R1 and R3 are selected, the higher the gain, the higher the CMRR. For example, when R2 = R4 = 10 kΩ, and R1 = R3 = 1 kΩ, and error = 0.1%, CMRR improves to greater than 80 dB. For high gain configuration, select amplifiers with very low I_{BIAS} and very high gain (such as the [ADA4661-2](#), [ADA4610-2](#), and [AD8667](#)) to reduce errors.
2. Select resistors that have much tighter tolerance and accuracy. The more closely they are matched, the better the CMRR. For example, if a CMRR of 90 dB is needed, match resistors to approximately 0.02%.

CURRENT-TO-VOLTAGE CONVERTER

Current can be measured in two ways with an operational amplifier. Current can be converted to a voltage with a resistor and then amplified, or injected directly into a summing node.

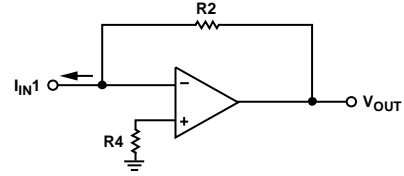

Figure 3. Current-to-Voltage Converter

Figure 3 is a typical representation of a current-to-voltage transducer. The input current is fed directly into the summing node and the amplifier output voltage changes to exactly the same current from the summing node through R2. The scale factor of this circuit is R2 volts per amp. The only conversion error in this circuit is I_{BIAS} , which is summed algebraically with I_{IN1} .

EXTERNAL COMPENSATION TECHNIQUES

Series Resistor Compensation

The use of external compensation networks is required to optimize certain applications. Figure 4 is a typical representation of a series resistor compensation for stabilizing an op amp driving capacitive load. The stabilizing effect of the series resistor isolates the op amp output and the feedback network from the capacitive load. The required amount of series resistance depends on the part used, but values of 5 Ω to 50 Ω are usually sufficient to prevent local resonance. The disadvantages of this technique are a reduction in gain accuracy and extra distortion when driving nonlinear loads.

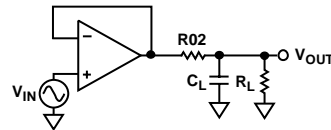

Figure 4. Series Resistor Compensation

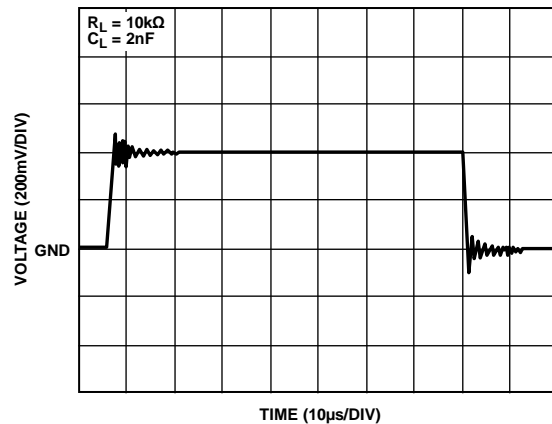

Figure 5. Capacitive Load Drive Without Resistor

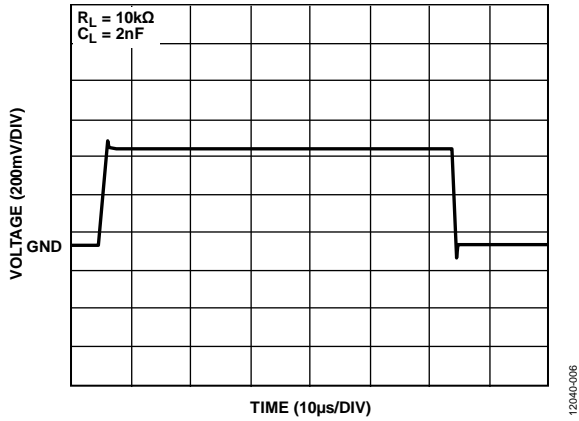

Figure 6. Capacitive Load Drive with Resistor

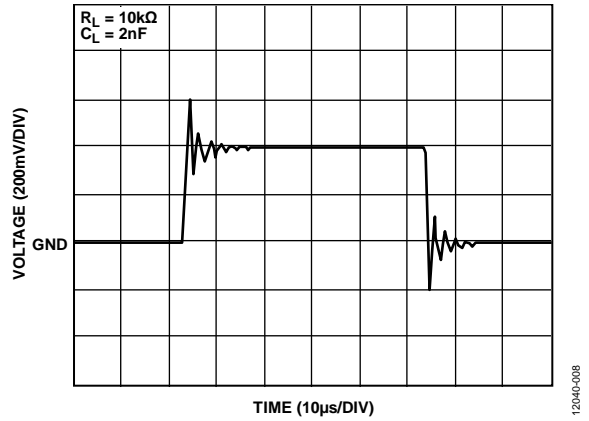

Figure 8. Capacitive Load Drive Without Snubber

Snubber Network

Another way to stabilize an op amp driving a capacitive load is with the use of a snubber, as shown in Figure 7. This method presents the significant advantage of not reducing the output swing because there is no isolation resistor in the signal path. Also, the use of the snubber does not degrade the gain accuracy or cause extra distortion when driving a nonlinear load. The exact R_s and C_s combinations can be determined experimentally.

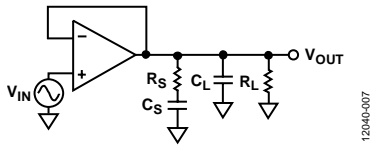

Figure 7. Snubber Network

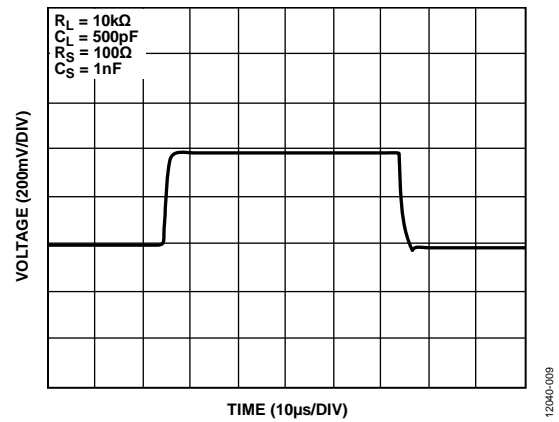

Figure 9. Capacitive Load Drive with Snubber

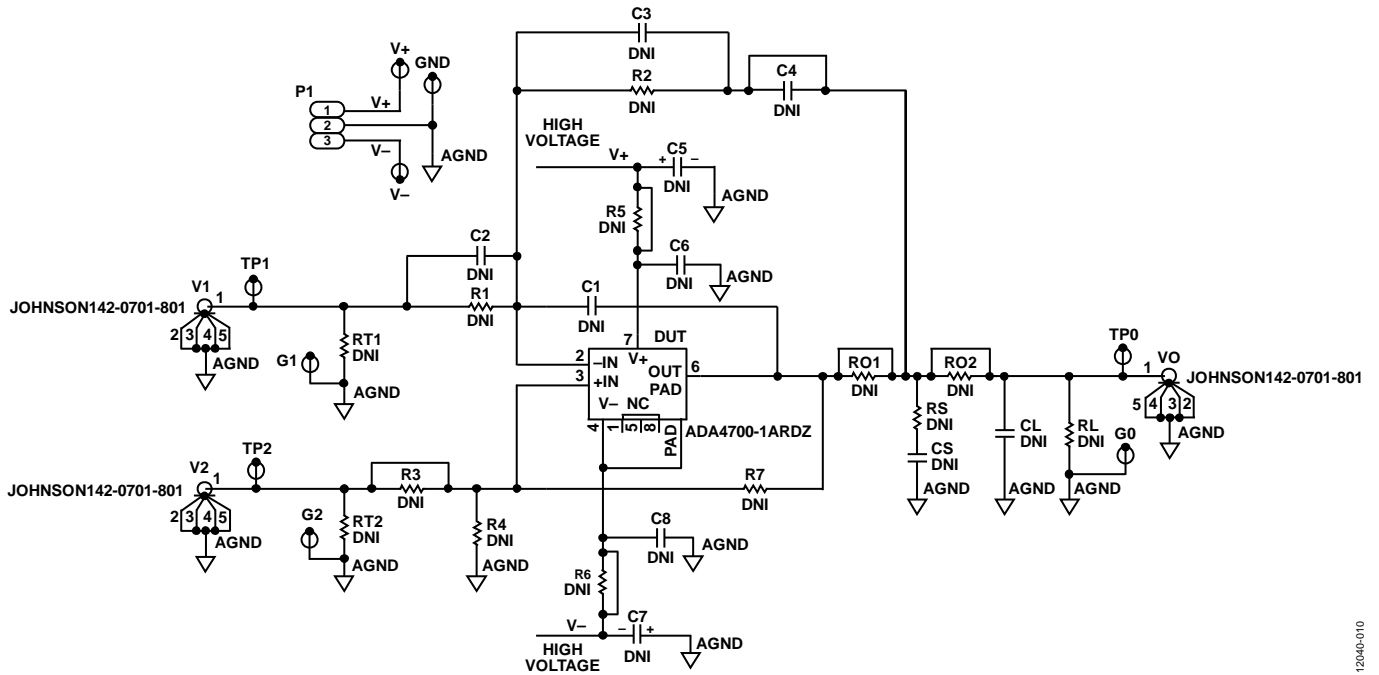

Figure 10. EVALPRAHVOPAMP-1RZ Electrical Schematic

